



GGSE-52S-MCI

Fork Properties

600kgs, Load capacity Forged Kingpin type Castors

- Single Piece forged alloy steel top plate with integrally forged kingpin
- Sealed double ball raceways precision CNC machined
- Induction Hardened raceways ensure longevity of the castor
- Forged lower raceway
- 6mm thick formed legs robotically welded inside & outside
- 12mm wheel axle
- Finish : Zinc plated; ROHS compliant or black polymer color coated
- Option : 4 way directional lock , Total lock, Wheel face brake

Wheel Properties

Muvtons special grey cast iron wheels solid core construction, tread face fully machined and crown treaded for extremely easy maneuverability. These wheels offer high abrasion and oil resistance can be used up to 600°C with appropriate wheel bearings. Wheel bearing options: Sealed precision ball bearings, tapered roller bearings or roller bearings. Temperature range : -100°C to +600°C.

Technical Data

Castor Type	Swivel Castor without Brake
Wheel Material	Cast Iron
Wheel Dia(mm)	125
Tread Width(mm)	50
Load Capacity(kg)	550
Wheel Bearing	Ball Bearing
Overall Height(mm)	165
Swivel Radius(mm)	101
Top Plate(mm)	138 x 110
Bolt Hole Dia(mm)	105 x 75-80
Non Marking	-
Heat Resistant	Yes
Noise Reduction	-

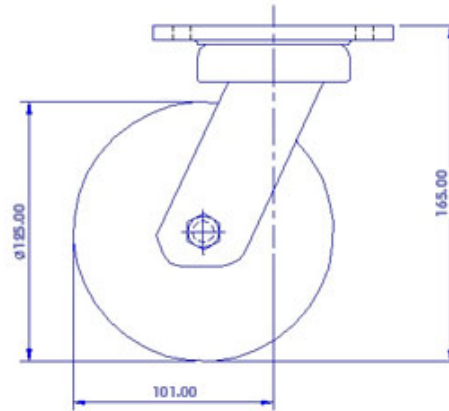

FRONT VIEW

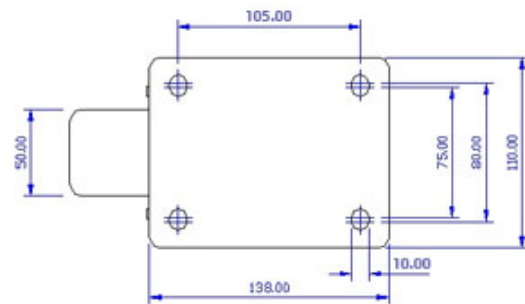

TOP VIEW