

FRONT VIEW

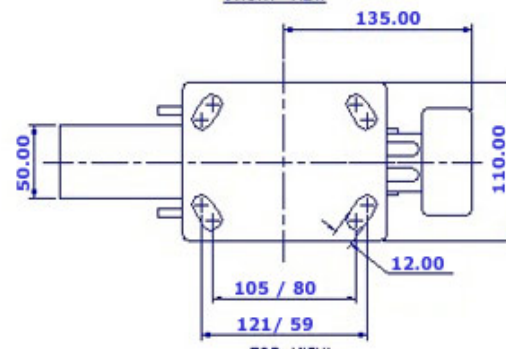

TOP VIEW

ALL DIMENSIONS ARE IN "mm"



GRDE-62S-SAS-TL