

FRONT VIEW

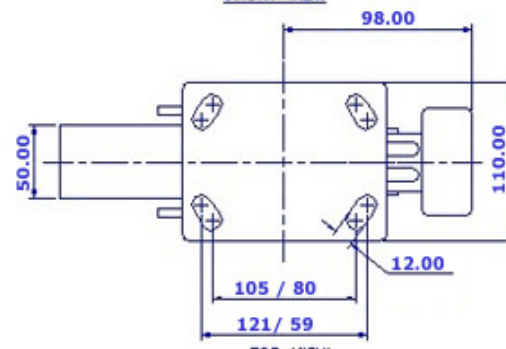

TOP VIEW

ALL DIMENSIONS ARE IN "mm"



GRDE-42S-SAS-TL