



GHKE-SS-52S-SFS

Fork Properties

900Kgs. Load Capacity Stainless Steel Kingpinless Castors

- Fabricated AISI 304 stainless steel top plate and fork base
- Precision CNC machined raceways
- Totally sealed swivel head with grease nipple
- 6mm thick formed legs robotically welded inside & outside to 65mm fork spacing
- 12mm wheel axle
- Finish : Polished bright finish or bead blasted
- Options : 4 way directional lock, Total lock, Wheel face brake

Wheel Properties

Muvtons exclusively designed " Real Solid " Elastomer Wheels produced from premium liquid cast polyurethane 73° ±3° shore d mechanically & chemically locked to a non corrosive metallic core that holds the wheel bearings and also provides structural rigidity under heavy loads. These wheels resist compression set, have excellent resilience for easy movement even under high loads and expel floor debris. Can be used for corrosive applications with suitable bearings. They are non marking and floor protective. Tested & guaranteed against bond failures. Wheel bearing options : sealed precision ball bearings, tapered roller bearings or roller bearings. Temperature range : -20°c to +85°c. Tread options:anti-static;conductive wheels are available.

Technical Data

Castor Type	Swivel Castor without Brake
Wheel Material	Polyurethane
Wheel Hardness	73° ± 3° Shore D
Wheel Center	Aluminium
Wheel Dia(mm)	125
Tread Width(mm)	50
Load Capacity(kg)	500
Wheel Bearing	Ball Bearing
Overall Height(mm)	165
Swivel Radius(mm)	95
Top Plate(mm)	138 x 110
Bolt Hole Centers	105 x 75-80
Non Marking	Yes
Heat Resistant	Yes
Noise Reduction	-

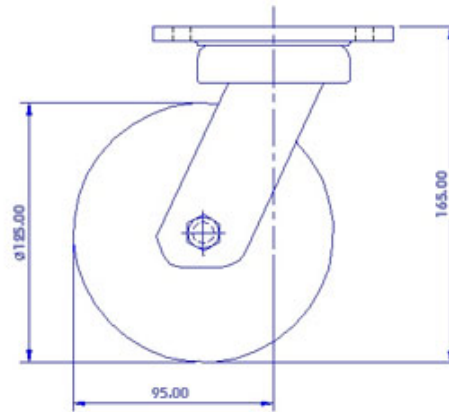

FRONT VIEW

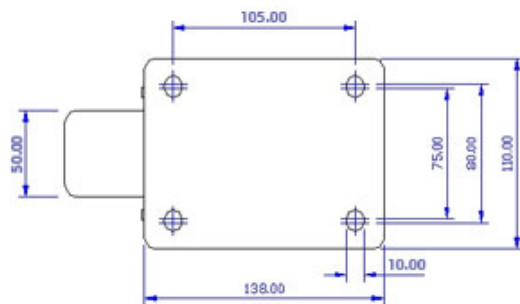

TOP VIEW