



ABE75-124S-SAS

Fork Properties

7500kgs load capacity forged precision bearing castors

- Single piece forged alloy steel top plate with an integrally forged kingpin & forged fork base
- Combination of precision thrust bearing and tapered roller bearing in the swivel head
- Totally sealed swivel head with grease nipple
- Slotted Nut and Cotter pin arrangement allow adjustment of swivel head play during usage
- 12 mm thick formed legs robotically welded inside & outside to 114mm fork spacing
- 30mm wheel axle
- Finish : Zinc Plated, ROHS compliant or black polymer color coated
- Options : 4 way directional lock, Wheel face brake

Wheel Properties

Muvtons premium polyurethane treaded wheels $93^{\circ} \pm 3^{\circ}$ Shore A, firmly bonded to precision machined cast iron cores offer low rolling resistance, smooth & noiseless running are non-marking and floor protective. These wheels possess high abrasion & cut resistance and are resistant to tearing. Tested & guaranteed against bond failures. Wheel bearing options : Sealed precision ball bearings, tapered roller bearings or roller bearings, color, light brown. Temperature range : -20°C to +85°C. Tread options: Anti static : Conductive wheels are available.

Technical Data

Castor Type	Swivel Castor without Brake
Wheel Material	Polyurethane
Wheel Hardness	$93^{\circ} \pm 3^{\circ}$ Shore A
Wheel Center	Cast Iron
Wheel Dia(mm)	300
Tread Width(mm)	100
Load Capacity(kg)	2800
Wheel Bearing	Ball Bearing
Overall Height(mm)	395
Swivel Radius(mm)	235
Top Plate(mm)	255 x 200
Bolt Hole Centers	210 x 160
Non Marking	Yes
Heat Resistant	Yes
Noise Reduction	Yes

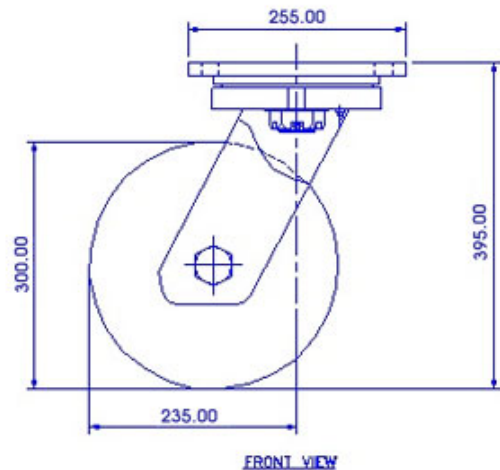

FRONT VIEW

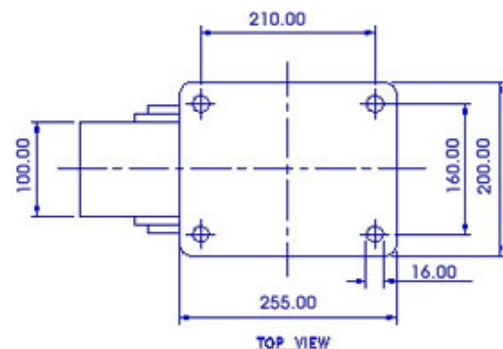

TOP VIEW