



GGSE-42S-SJS

Fork Properties

600kgs, Load capacity Forged Kingpin type Castors

- Single Piece forged alloy steel top plate with integrally forged kingpin
- Sealed double ball raceways precision CNC machined
- Induction Hardened raceways ensure longevity of the castor
- Forged lower raceway
- 6mm thick formed legs robotically welded inside & outside
- 12mm wheel axle
- Finish : Zinc plated; ROHS compliant or black polymer color coated
- Option : 4 way directional lock , Total lock, Wheel face brake

Wheel Properties

Muvtons medium duty polyurethane treaded wheels 93° ±3C Shore A for medium and light applications offer a cost effective yet a good solution Polyurethane treads is firmly bonded to precision machined and floor protective. Tested & Guaranteed against bond failures. Wheel bearing options: Sealed precision ball bearings, tapered roller bearings or roller bearings. Color: Light Brown, Temperature Range : -20°C to +85°C.

Technical Data

Castor Type	Swivel Castor without Brake
Wheel Material	Polyurethane
Wheel Hardness	93° ± 3° Shore A
Wheel Center	Cast Iron
Wheel Dia(mm)	100
Tread Width(mm)	50
Load Capacity(kg)	325
Wheel Bearing	Ball Bearing
Overall Height(mm)	143
Swivel Radius(mm)	85
Top Plate(mm)	138 x 110
Bolt Hole Centers	105 x 75-80
Non Marking	Yes
Heat Resistant	Yes
Noise Reduction	Yes

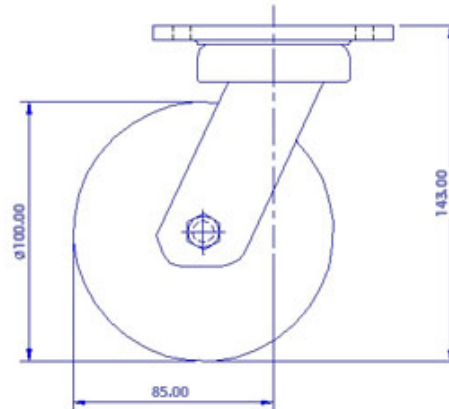

FRONT VIEW

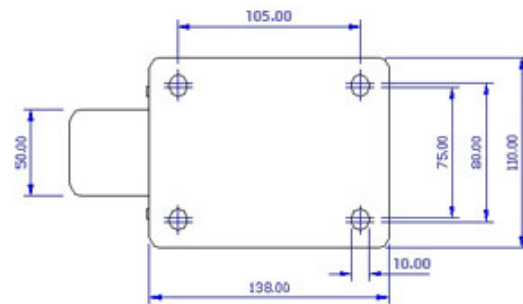

TOP VIEW