



BHS-312R-RNY

Fork Properties

350Kgs. Load Capacity Medium Duty Castors

- Heavy duty pressed steel brackets
- Swivel brackets with double ball bearing raceways, dynamically pressed ensure low swivel headplay and long service life
- Kingpinless swivel head design in larger wheel diameters eliminates chances of kingpin failure
- Finish : Zinc Plated
- Options : Total lock brake system

Wheel Properties

Muvtons black elastic rubber tyred wheels firmly chemically bonded to precision machined cast iron cores. Highly resilient 75° ±5° Shore A rubber provides very smooth and silent running. Can be used for power towing applications by suitably de-rating the load capacity. Wheel bearing options: Sealed precision ball bearings, tapered roller bearings or roller bearings. Temperature range : -20°C +75°C Tread Options: Anti Static, conductive and oil resistant wheels are available.

Technical Data

Castor Type	Rigid Castor without Brake
Wheel Material	Elastic Rubber
Wheel Hardness	75° ± 5° Shore A
Wheel Center	Nylon Polyamide
Wheel Dia(mm)	80
Tread Width(mm)	30
Load Capacity(kg)	100
Wheel Bearing	Ball Bearing
Overall Height(mm)	105
Top Plate(mm)	105 x 85
Bolt Hole Centers	82 x 62 to 78 x 58
Non Marking	Yes
Heat Resistant	Yes
Noise Reduction	

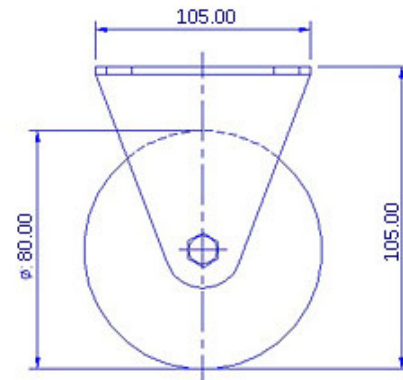

FRONT VIEW

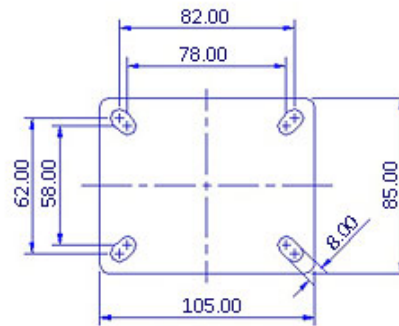

TOP VIEW