



BDS-62R-SEB

Fork Properties

450Kgs. Load Capacity Heavy Duty Pressed Steel Castors

- Extra heavy duty pressed steel brackets thick steel construction
- Swivel brackets with double ball bearing raceways dynamically pressed ensure low swivel head play and long service life
- Kingpinless swivel head design in larger wheel diameters eliminates chances of kingpin failure
- Finish : Zinc Plated
- Options : Total Lock Brake System

Wheel Properties

Muvtons black elastic rubber tyred wheels firmly chemically bonded to precision machined cast iron cores. Highly resilient 75° ±5° Shore A rubber provides very smooth and silent running. Can be used for power towing applications by suitably de-rating the load capacity. Wheel bearing options: Sealed precision ball bearings, tapered roller bearings or roller bearings. Temperature range : -20°C +75°C Tread Options: Anti Static, conductive and oil resistant wheels are available.

Technical Data

Castor Type	Rigid Castor without Brake
Wheel Material	Elastic Rubber
Wheel Hardness	75° ± 5° Shore A
Wheel Center	Cast Iron
Wheel Dia(mm)	150
Tread Width(mm)	50
Load Capacity(kg)	350
Wheel Bearing	Ball Bearing
Overall Height(mm)	190
Top Plate(mm)	105 x 85
Bolt Hole Centers	80 x 60
Non Marking	-
Heat Resistant	Yes
Noise Reduction	Yes

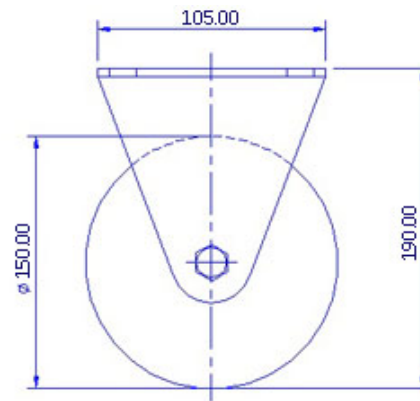

FRONT VIEW

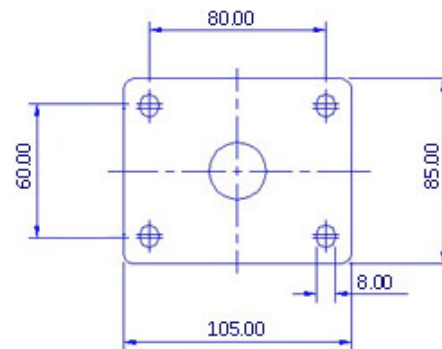

TOP VIEW